

MUNA

UA ТЕХНІЧНА ІНФОРМАЦІЯ

Каркас: сосновий брус, березова фанера класу E1 (Литва)

Додаткові елементи каркасу: ДСП

Наповнювач подушок сидінь: еластичний пінополіуретан, сировина BAYER, BASF (Німеччина), SHELL (Нідерланди), формування Interfoam (Україна)

Наповнювач спинних подушок: холофайбер

Рівень м'якості: середній SS/Medium

Ніжки: дерево

Клей для каркасу: Jowat (Німеччина)

Клей для пінополіуретану: Saba (Нідерланди)

Розкладний механізм: викочування

Ніша для білизни у кутовій конфігурації

EN TECHNICAL INFORMATION

Frame: pine beam, class E1 birch plywood (Lithuania)

Additional frame elements: chipboard

Filling: seat cushions — flexible polyurethane foam, BAYER, BASF (Germany), SHELL (Netherlands) raw materials, Interfoam (Ukraine) moulding

Back cushions and throw pillows: hollowfiber

Seats softness: medium SS/Medium

Legs: wood

Glue for the frame: Jowat (Germany)

Glue for polyurethane foam: Saba (Netherlands)

Mechanism: Roll-out

Storage box for bed linen in corner configuration



MOOD

MUNA

120MU-123

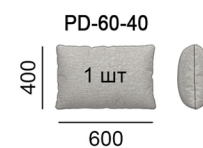
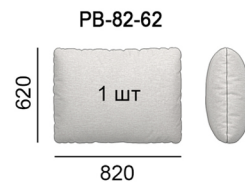
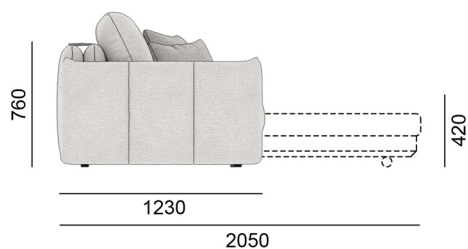
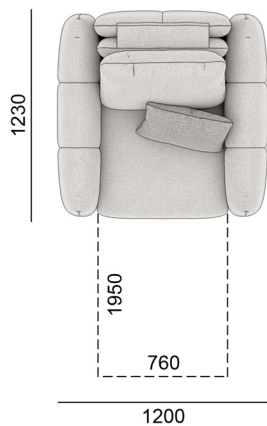

150MU-123

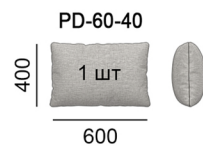
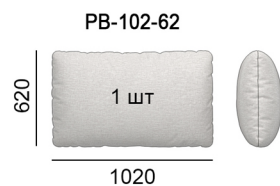
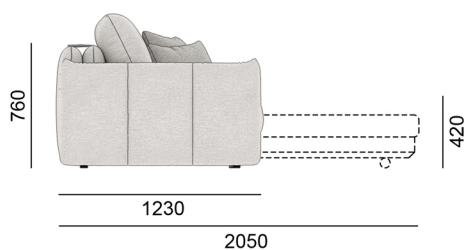
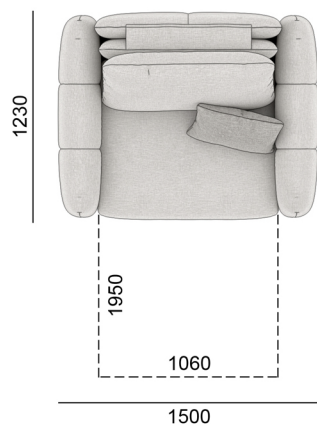

170MU-123

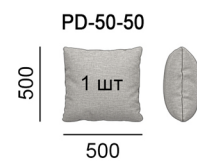
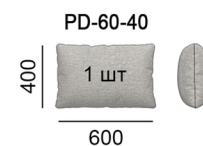
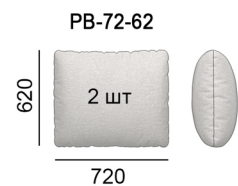
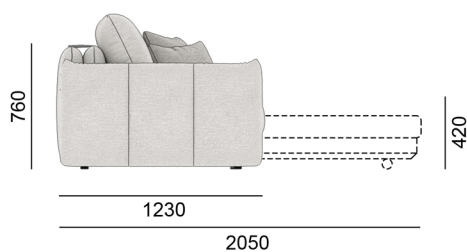
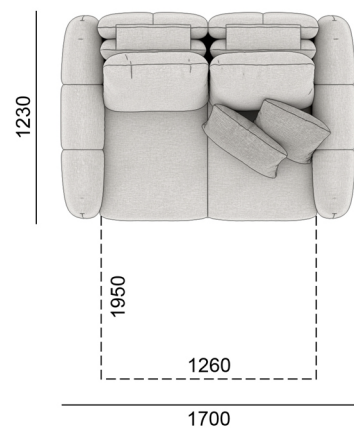

MUNA

190MU-123

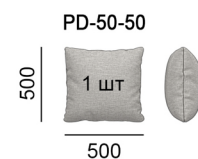
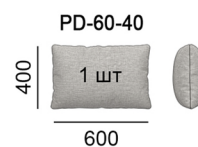
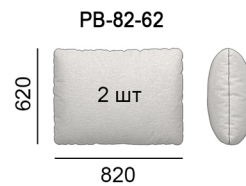
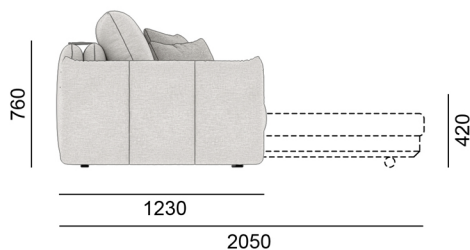
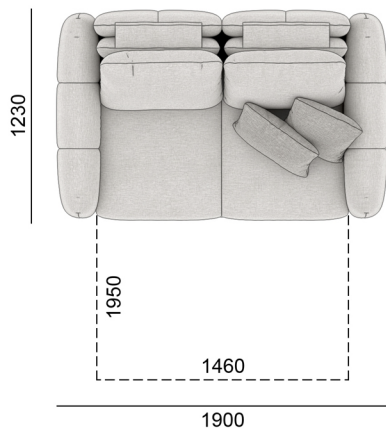

210MU-123

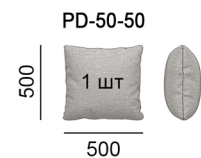
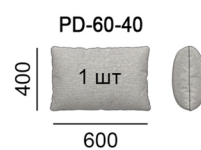
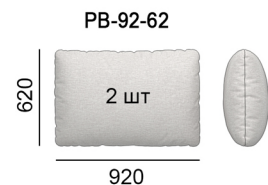
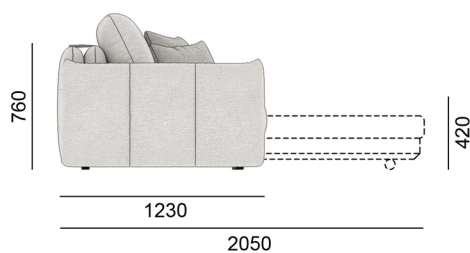
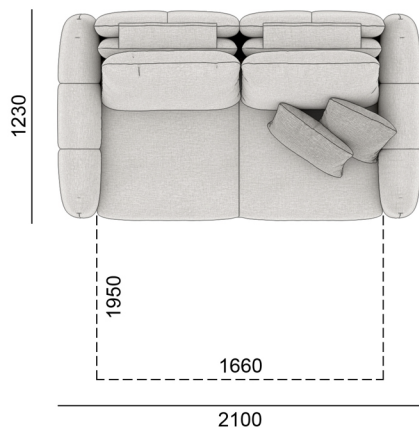

230MU-123

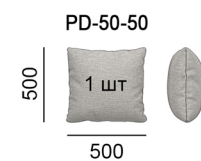
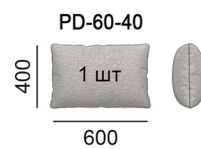
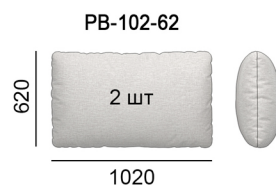
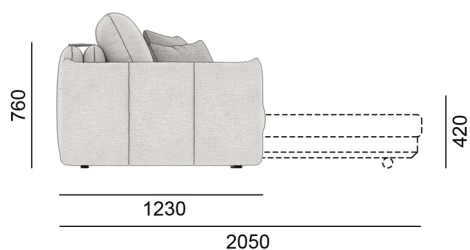
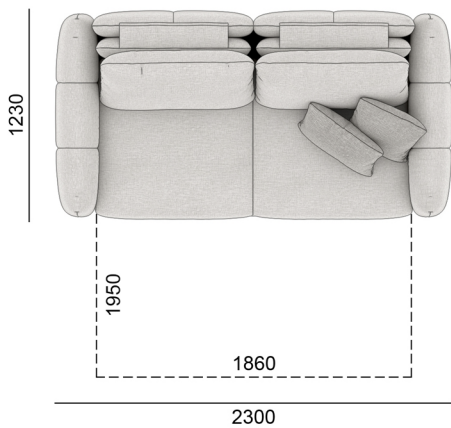

MUNA

260MU-180-CL

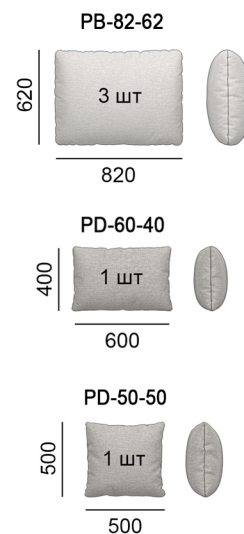
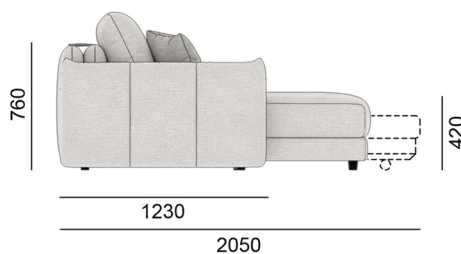
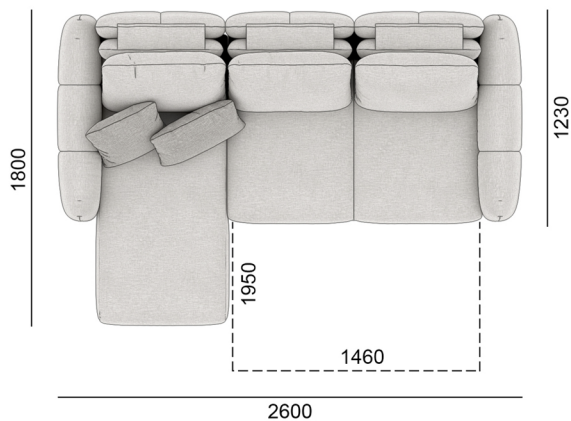

260MU-180-CR

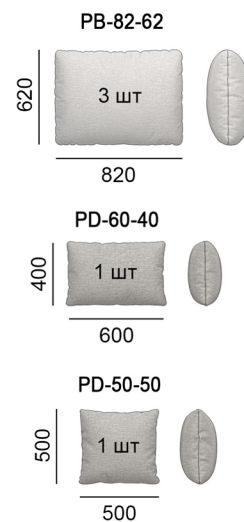
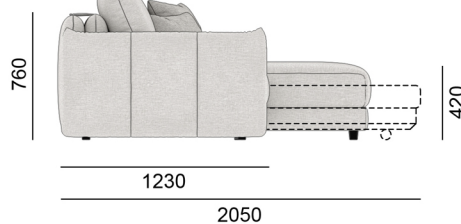
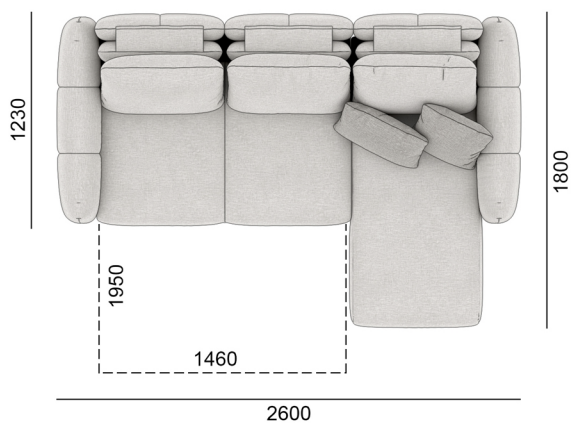

290MU-180-CL

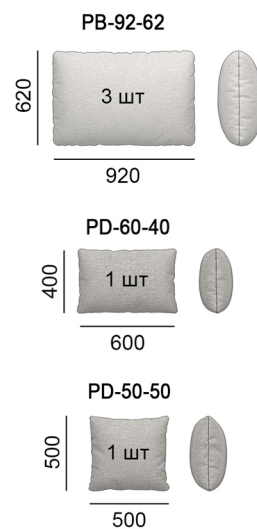
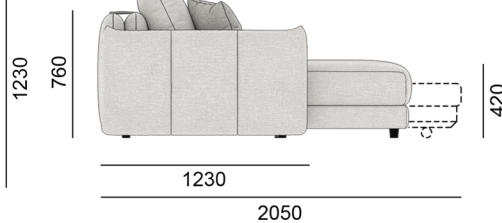
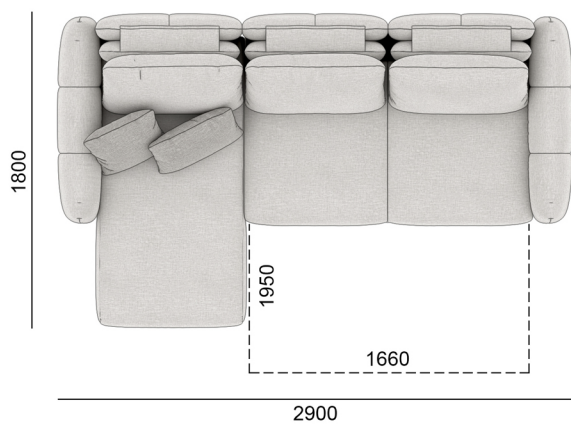

MUNA

290MU-180-CR

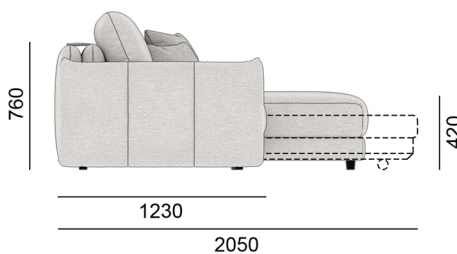
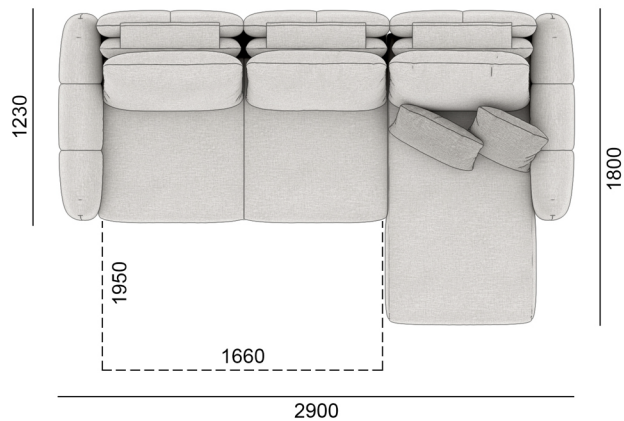

PB-92-62

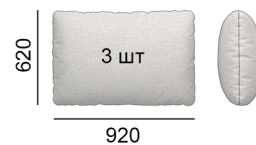

PD-60-40



PD-50-50

